

Powered by



# HRL 12330W ▶ 12V 330W

HRL 12330W is specially designed for high efficient discharge application. Its characteristics are high energy density, small footprint and high discharge efficiency. It can be used for more than 260 cycles at 100% discharge in cycle service, up to 10 years in standby service.



## Specification

|  |   |
|--|---|
| Cells per unit                             | 6   |
| Voltage per unit                           | 12  |
| Capacity                                   | 330 W @15min-rate to 1.67V per cell @25 °C(77°F)  |
| Weight                                     | Approx.29.6 kg(65.26 lbs)   |
| Maximum Discharge Current                  | 800A(5sec)  |
| Internal Resistance                        | Approx. 4 mΩ  |
| Operating Temperature Range                | Discharge: -15°C~50°C( 5°F~122°F)<br>Charge: -15 °C~40°C( 5°F~104°F)<br>Storage: -15°C~40°C( 5°F~104°F)   |
| Nominal Operating Temperature Range        | 25°C±3°C (77°F±5°F)   |
| Float Charging Voltage                     | 13.5 to 13.8 VDC/unit Average at 25°C (77°F)  |
| Recommended Maximum Charging Current Limit | 33A   |
| Equalization and Cycle Service             | 14.4 to 15.0 VDC/unit Average at 25°C (77°F)  |
| Self Discharge                             | CSB Batteries can be stored for more than 6 months at 25°C (77°F). Please charge batteries before using. For higher temperatures the time interval will be shorter. |
| Terminal                                   | I2-Thread lead alloy recessed terminal to accept M6/M8 bolt   |
| Container Material                         | Polypropylene(UL 94-V0/File E50955)*Flammability resistance of (UL 94-HB/File E216959) can be available upon request.   |



CSB-manufactured VRLA batteries are UL-recognized components under UL924 and UL1989.

CSB is also certified by ISO 9001 and ISO 14001.

| Dimensions :    | Overall Height (H)   | Container height (h) | Length (L)            | Width (W)         |
|-----------------|----------------------|----------------------|-----------------------|-------------------|
| Unit: mm (inch) | 214.3±2.5 (8.44±0.1) | 211.3±2.5 (8.32±0.1) | 308.7±2.5 (12.15±0.1) | 169±2 (6.65±0.08) |

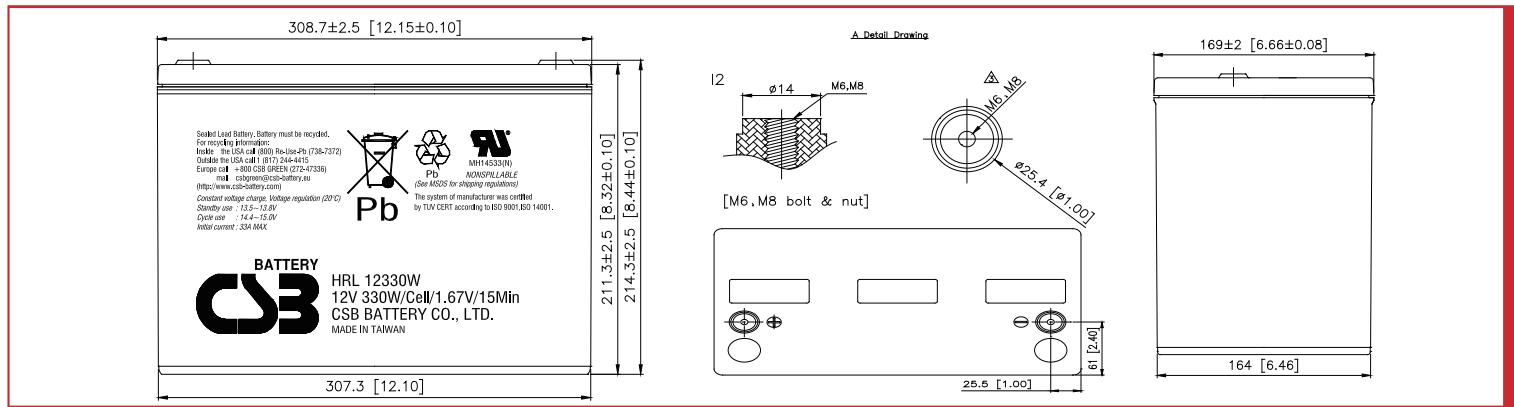

## Constant Current Discharge Characteristics Unit:A (25°C, 77°F)

| F.V/Time | 5MIN | 10MIN | 15MIN | 20MIN | 30MIN | 40MIN | 45MIN | 50MIN | 60MIN | 90MIN |
|----------|------|-------|-------|-------|-------|-------|-------|-------|-------|-------|
| 1.60V    | 383  | 260   | 201   | 165   | 123   | 98.4  | 89.9  | 82.0  | 70.2  | 52.1  |
| 1.67V    | 339  | 239   | 188   | 157   | 117   | 94.2  | 85.3  | 78.1  | 67.1  | 49.4  |
| 1.70V    | 318  | 229   | 181   | 152   | 113   | 91.1  | 83.4  | 76.4  | 64.9  | 47.3  |
| 1.75V    | 284  | 210   | 168   | 144   | 106   | 85.6  | 78.9  | 72.5  | 61.2  | 44.4  |
| 1.80V    | 253  | 193   | 158   | 135   | 98.4  | 79.6  | 72.5  | 66.4  | 56.6  | 41.6  |
| 1.85V    | 219  | 177   | 147   | 125   | 92.5  | 74.9  | 68.5  | 62.5  | 53.5  | 39.5  |

## Constant Power Discharge Characteristics Unit:W (25°C, 77°F)

| F.V/Time | 5MIN  | 10MIN | 15MIN | 20MIN | 30MIN | 40MIN | 45MIN | 50MIN | 60MIN | 90MIN |
|----------|-------|-------|-------|-------|-------|-------|-------|-------|-------|-------|
| 1.60V    | 4,044 | 2,772 | 2,148 | 1,770 | 1,320 | 1,062 | 972   | 888   | 762   | 566   |
| 1.67V    | 3,621 | 2,608 | 2,040 | 1,712 | 1,290 | 1,032 | 936   | 864   | 744   | 547   |
| 1.70V    | 3,438 | 2,520 | 1,979 | 1,679 | 1,266 | 1,008 | 924   | 852   | 726   | 529   |
| 1.75V    | 3,115 | 2,354 | 1,891 | 1,605 | 1,210 | 963   | 894   | 816   | 696   | 503   |
| 1.80V    | 2,791 | 2,180 | 1,795 | 1,528 | 1,145 | 918   | 833   | 762   | 650   | 484   |
| 1.85V    | 2,478 | 2,016 | 1,690 | 1,428 | 1,070 | 864   | 786   | 720   | 613   | 460   |

### Trickle (or Float) Service Life

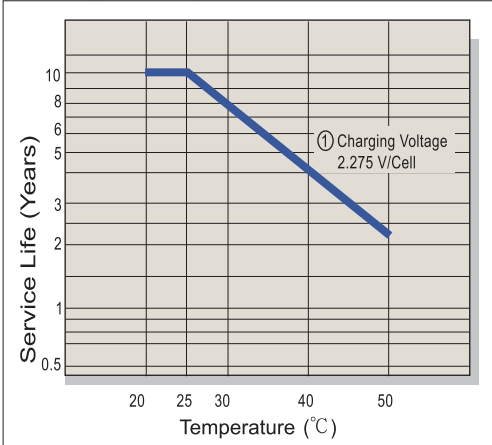

### Capacity Retention Characteristic

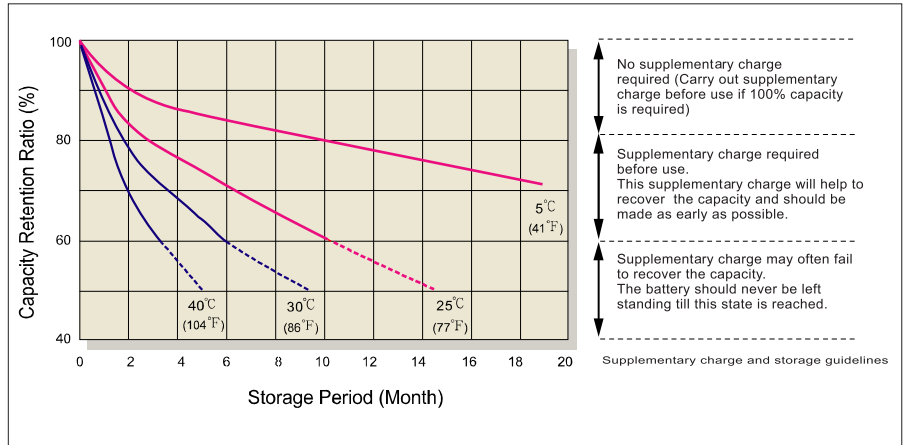

### Battery Voltage and Charge Time for Standby Use

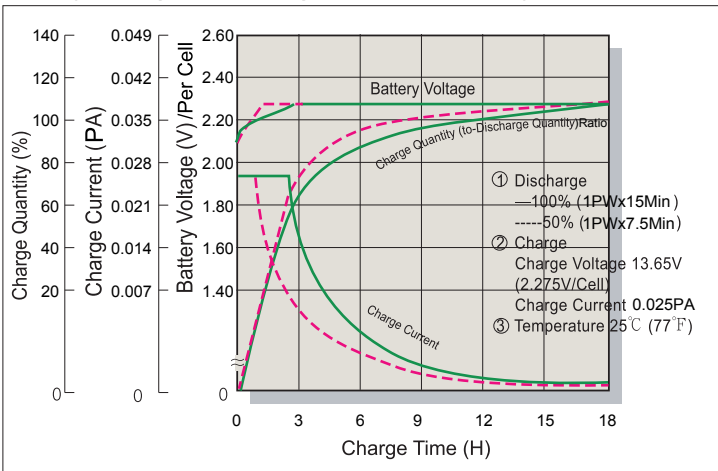

### Cycle Service Life

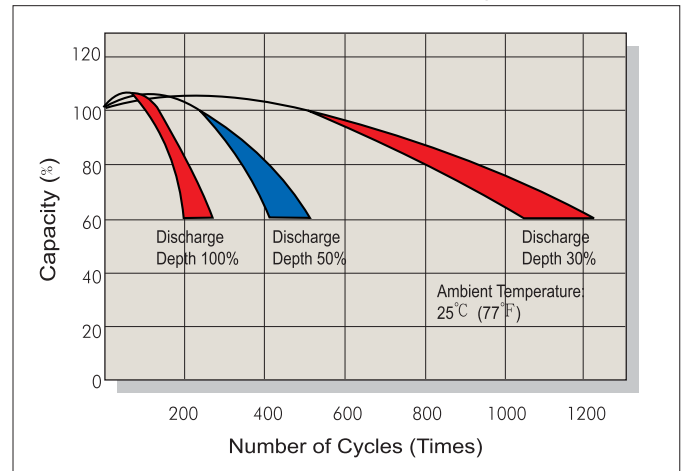

### Battery Voltage and Charge Time for Cycle Use

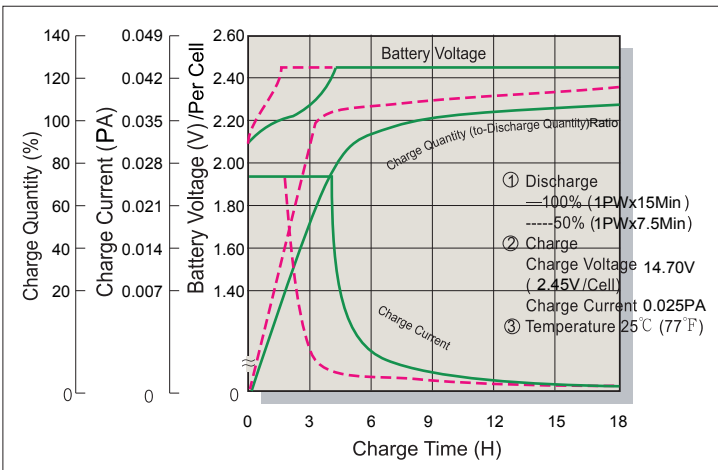

### Terminal Voltage (V) and Discharge Time

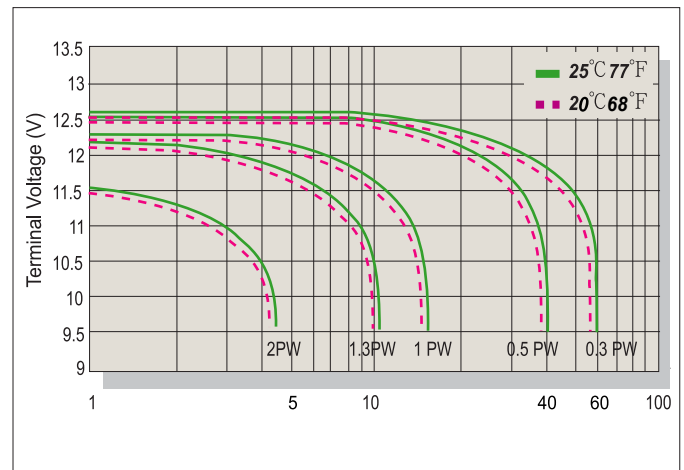

### Charging Procedures

| Application | Charge Voltage(V/Cell) |           |                 | Max.Charge Current |
|-------------|------------------------|-----------|-----------------|--------------------|
|             | Temperature            | Set Point | Allowable Range |                    |
| Cycle Use   | 25°C(77°F)             | 2.45      | 2.40~2.50       | 0.1PA              |
| Standby     | 25°C(77°F)             | 2.275     | 2.25~2.30       |                    |

### Discharge Current VS. Discharge Voltage

| Final Discharge Voltage V/Cell | 1.75     | 1.70           | 1.60           | 1.30     |
|--------------------------------|----------|----------------|----------------|----------|
| Discharge Power(W)             | 0.1P>(W) | 0.1P≤(W)<0.25P | 0.25P≤(W)<1.0P | (W)≥1.0P |

Sales Office URL: [WWW.CSB-BATTERY.COM](http://WWW.CSB-BATTERY.COM)

**GLOBAL HQ**  
**CSB BATTERY CO., LTD. (TAIWAN)**  
 Tel : +886-2-2555-5600  
 Fax : +886-2-2555-3300  
 mail : [service@csb-battery.com.tw](mailto:service@csb-battery.com.tw)

**BEIJING OFFICE. (CHINA)**  
**CSB BATTERY TECHNOLOGIES (BEIJING) CO., LTD.**  
 Tel : +86-10-59621300/1301/1302/1303  
 Fax : +86-10-59621304  
 mail : [chinasls@csb-battery.com](mailto:chinasls@csb-battery.com)

**AMERICA HQ**  
**CSB BATTERY TECHNOLOGIES INC. (U.S.A)**  
 Tel : +1-817-244-7777/1-(800)3-CSB-USA(272872)  
 Fax : +1-817-244-4445  
 mail : [csb@csb-battery.com](mailto:csb@csb-battery.com)

**SHANGHAI OFFICE. (CHINA)**  
**CSB BATTERY LOGISTIC (SHANGHAI) CO., LTD.**  
 Tel : +86-21-5046-1622/5046-0833  
 Fax : +86-21-5064-3314  
 mail : [chinasls@csb-battery.com](mailto:chinasls@csb-battery.com)

**EUROPE HQ**  
**CSB Battery Europe BV.**  
 Tel : +31(0)-180-418-140  
 Fax : +31(0)-180-418-327  
 mail : [eurosales@csb-battery.eu](mailto:eurosales@csb-battery.eu)

**SHENZHEN OFFICE. (CHINA)**  
**CSB BATTERY LOGISTIC (SHANGHAI) CO., LTD.**  
 Tel : +86-755-8831-6488/6396/6356  
 Fax : +86-755-8831-6548  
 mail : [she@csb-battery.com.cn](mailto:she@csb-battery.com.cn)