

Powered by



HRL 12200W ▶ 12V 200W

HRL 12200W is specially designed for high efficient discharge application. Its characteristics are high energy density, small footprint and high discharge efficiency. It can be used for more than 260 cycles at 100% discharge in cycle service, up to 10 years in standby service.



Specification

Cells per unit	6
Voltage per unit	12
Capacity	200W @ 15min-rate to 1.67V per cell @25 °C(77°F)
Weight	Approx. 17.6 kg(38.8 lbs)
Maximum Discharge Current	300A(5sec)
Internal Resistance	Approx. 5.9 mΩ
Operating Temperature Range	Discharge: -15°C~50°C (5°F~122°F) Charge: -15 °C~40°C(5°F~104°F) Storage: -15°C~40°C(5°F~104°F)
Nominal Operating Temperature Range	25°C±3°C (77°F±5°F)
Float Charging Voltage	13.5 to 13.8 VDC/unit Average at 25°C (77°F)
Recommended Maximum Charging Current Limit	20A
Equalization and Cycle Service	14.4 to 15.0 VDC/unit Average at 25°C (77°F)
Self Discharge	CSB Batteries can be stored for more than 6 months at 25°C (77°F). Please charge batteries before using. For higher temperatures the time interval will be shorter.
Terminal	I2-Thread lead alloy recessed terminal to accept M6 bolt
Container Material	Polypropylene(UL 94-V0/File E50955)*Flammability resistance of (UL 94-HB/File E216959) can be available upon request.



CSB-manufactured VRLA batteries are UL-recognized components under UL924 and UL1989.

CSB is also certified by ISO 9001 and ISO 14001.

Dimensions :	Overall Height (H)	Container height (h)	Length (L)	Width (W)
Unit: mm (inch)	207.3±2.5 (8.161±0.98)	202.3±2.5 (7.96±0.98)	228±2.5 (8.97±0.98)	138.4±1.5 (5.45±0.59)

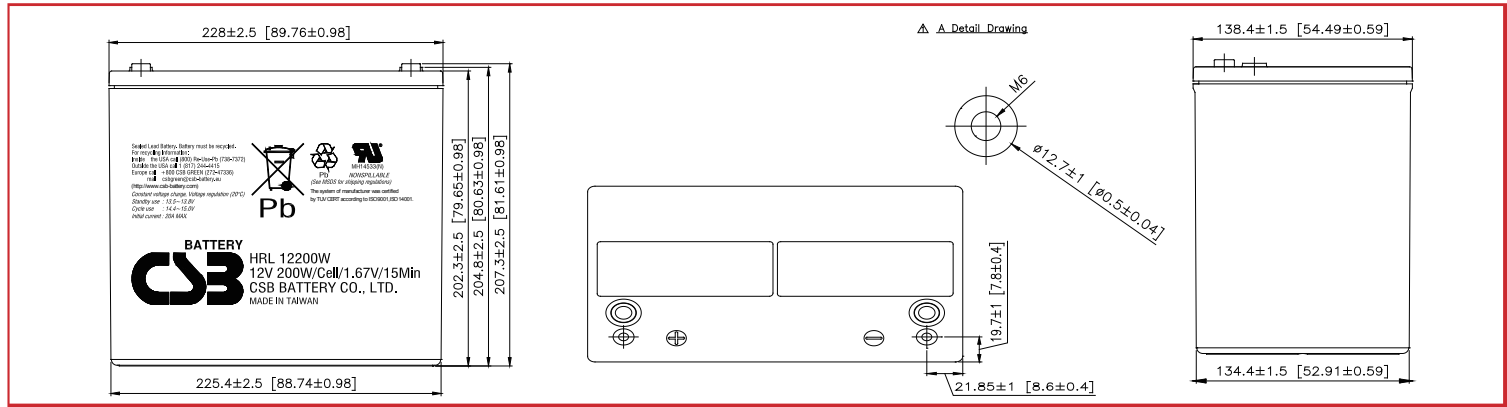

Constant Current Discharge Characteristics Unit:A (25°C, 77°F)

F.V/Time	5MIN	7.5MIN	10MIN	15MIN	20MIN	30MIN	40MIN	50MIN	60MIN	90MIN
1.60V	225	184	155	116	92.7	67.2	53.4	44.6	38.5	27.7
1.67V	205	169	144	110	89.4	64.7	52.0	44.3	38.1	27.4
1.70V	195	163	138	108	87.6	63.6	51.1	43.9	37.8	27.3
1.75V	177	150	128	103	83.6	61.2	49.5	42.8	37.0	26.7
1.80V	159	138	119	95.7	79.0	58.7	47.4	41.0	35.7	26.0
1.85V	142	125	110	89.3	73.4	55.6	44.8	38.1	33.3	24.8

Constant Power Discharge Characteristics Unit:W (25°C, 77°F)

F.V/Time	5MIN	7.5MIN	10MIN	15MIN	20MIN	30MIN	40MIN	50MIN	60MIN	90MIN
1.60V	2,392	1,972	1,684	1,290	1,050	770	618	516	447	325
1.67V	2,176	1,842	1,589	1,235	1,010	748	612	514	445	323
1.70V	2,081	1,774	1,540	1,208	988	737	607	510	443	322
1.75V	1,914	1,648	1,449	1,160	945	710	594	499	434	315
1.80V	1,747	1,526	1,359	1,093	900	683	568	481	419	308
1.85V	1,584	1,410	1,258	1,031	852	649	528	450	395	295

Trickle (or Float) Service Life

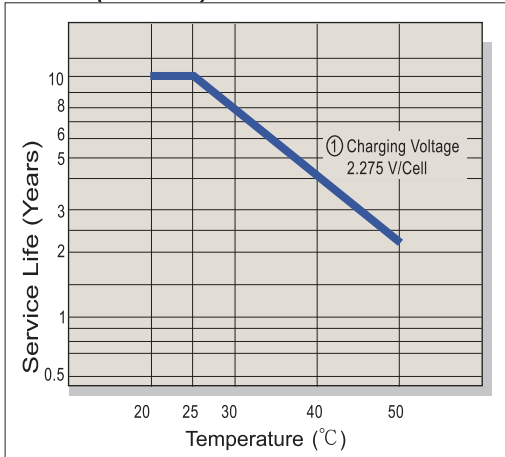

Capacity Retention Characteristic

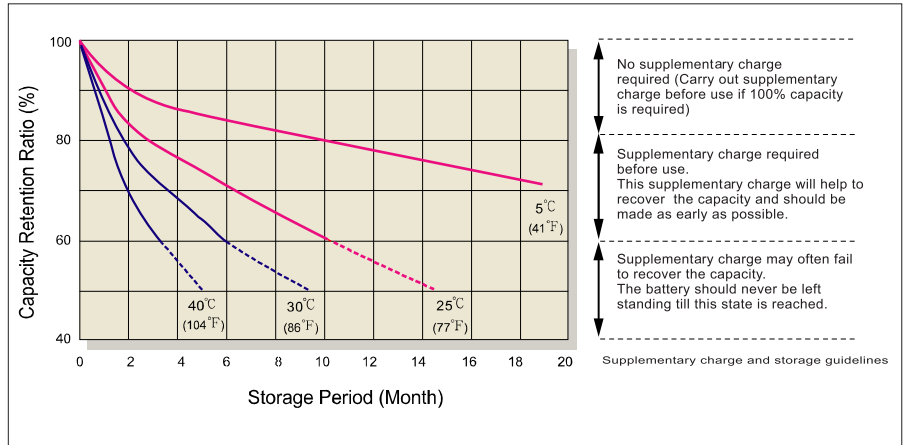

Battery Voltage and Charge Time for Standby Use

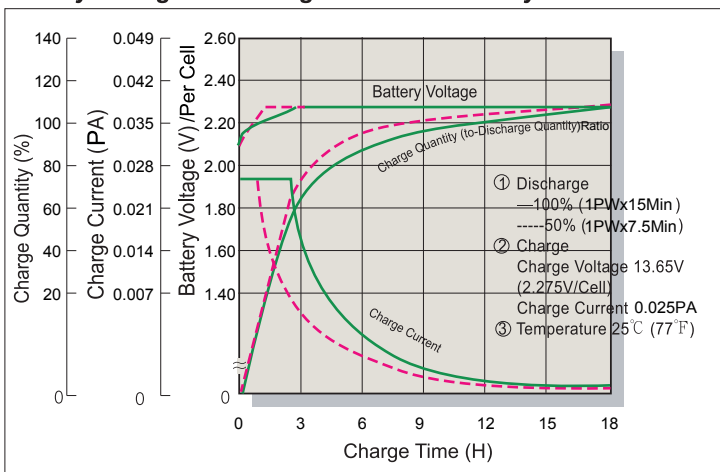

Cycle Service Life

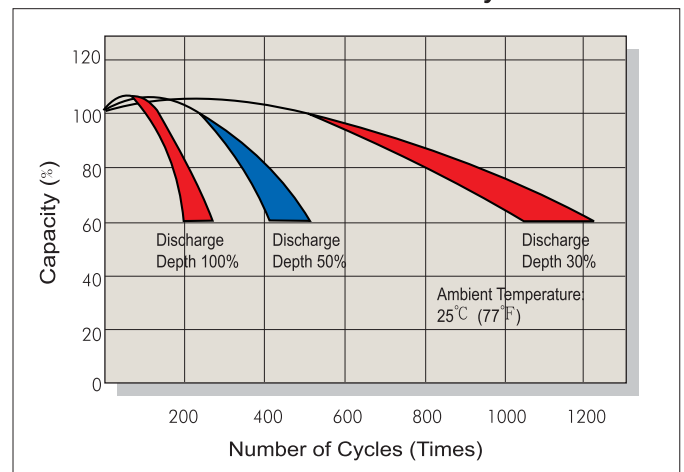

Battery Voltage and Charge Time for Cycle Use

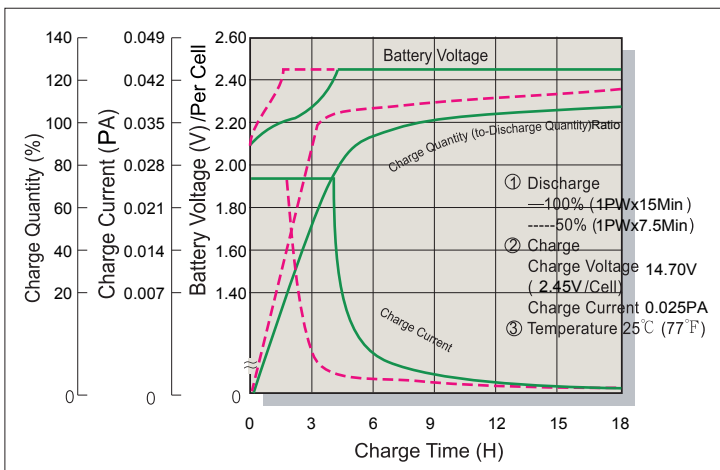

Terminal Voltage (V) and Discharge Time

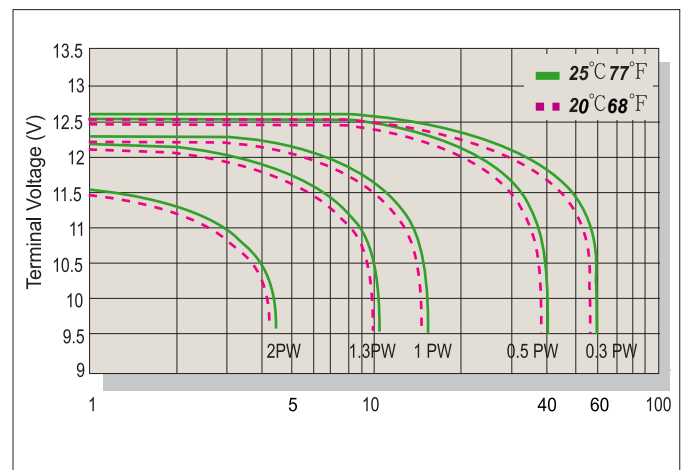

Charging Procedures

Application	Charge Voltage(V/Cell)			Max.Charge Current
	Temperature	Set Point	Allowable Range	
Cycle Use	25°C(77°F)	2.45	2.40~2.50	0.1PA
Standby	25°C(77°F)	2.275	2.25~2.30	

Discharge Current VS. Discharge Voltage

Final Discharge Voltage V/Cell	1.75	1.70	1.60	1.30
Discharge Power(W)	0.1P>(W)	0.1P≤(W)<0.25P	0.25P≤(W)<1.0P	(W)≥1.0P

Sales Office URL: WWW.CSB-BATTERY.COM

GLOBAL HQ
CSB BATTERY CO., LTD. (TAIWAN)
 Tel : +886-2-2555-5600
 Fax : +886-2-2555-3300
 mail : service@csb-battery.com.tw

BEIJING OFFICE. (CHINA)
CSB BATTERY TECHNOLOGIES (BEIJING) CO., LTD.
 Tel : +86-10-59621300/1301/1302/1303
 Fax : +86-10-59621304
 mail : chinasl@csb-battery.com

AMERICA HQ
CSB BATTERY TECHNOLOGIES INC. (U.S.A)
 Tel : +1-817-244-7777/1-(800)3-CSB-USA(272872)
 Fax : +1-817-244-4445
 mail : csb@csb-battery.com

SHANGHAI OFFICE. (CHINA)
CSB BATTERY LOGISTIC (SHANGHAI) CO., LTD.
 Tel : +86-21-5046-1622/5046-0833
 Fax : +86-21-5064-3314
 mail : chinasl@csb-battery.com

EUROPE HQ
CSB Battery Europe BV.
 Tel : +31(0)-180-418-140
 Fax : +31(0)-180-418-327
 mail : eurosales@csb-battery.eu

SHENZHEN OFFICE. (CHINA)
CSB BATTERY LOGISTIC (SHANGHAI) CO., LTD.
 Tel : +86-755-8831-6488/6396/6356
 Fax : +86-755-8831-6548
 mail : she@csb-battery.com.cn