

Powered by



GPL 121000 ▶ 12V 100Ah

GPL 121000 is a general purpose battery up to 10 years in standby service or more than 260 cycles at 100% discharge in cycle service . As with all CSB batteries, all are rechargeable , highly efficient , leak proof and maintenance free.



► Specification

Cells Per Unit	6
Voltage Per Unit	12
Capacity	100Ah @ 20hr-rate to 1.75V per cell @25 °C (77°F)
Weight	Approx. 33.5 kg (73.86 lbs)
Maximum Discharge Current	800A(5sec)
Internal Resistance	Approx. 3.5 mΩ
Operating Temperature Range	Discharge: -15°C~50°C (5°F~122°F) Charge: -15 °C~40°C (5°F~104°F) Storage: -15°C~40°C (5°F~104°F)
Nominal Operating Temperature Range	25°C±3°C (77°F±5°F)
Float Charging Voltage	13.5 to 13.8 VDC/unit Average at 25°C (77°F)
Recommended Maximum Charging Current Limit	30 A
Equalization and Cycle Service	14.4 to 15.0 VDC/unit Average at 25°C (77°F)
Self Discharge	CSB Batteries can be stored for more than 6 months at 25°C (77°F) . Please charge batteries before using . For higher temperatures the time interval will be shorter.
Terminal	I2-Thread lead alloy recessed terminal to accept M6/M8 bolt
Container Material	Polypropylene(UL 94-V0/File E50955)*Flammability resistance of (UL 94-HB/File E216959) can be available upon request.



MH14533(N)



No.:041005117



CSB-manufactured VRLA batteries are UL-recognized components under UL924 and UL1989.

CSB is also certified by ISO 9001 and ISO 14001.

► Dimensions :

Unit: mm (inch)

Overall Height (H)	Container height (h)	Length (L)	Width (W)
217.6±2.5 (8.57±0.1)	214.6±2.5 (8.45±0.1)	343±2.5 (13.5±0.1)	170±2 (6.69±0.08)

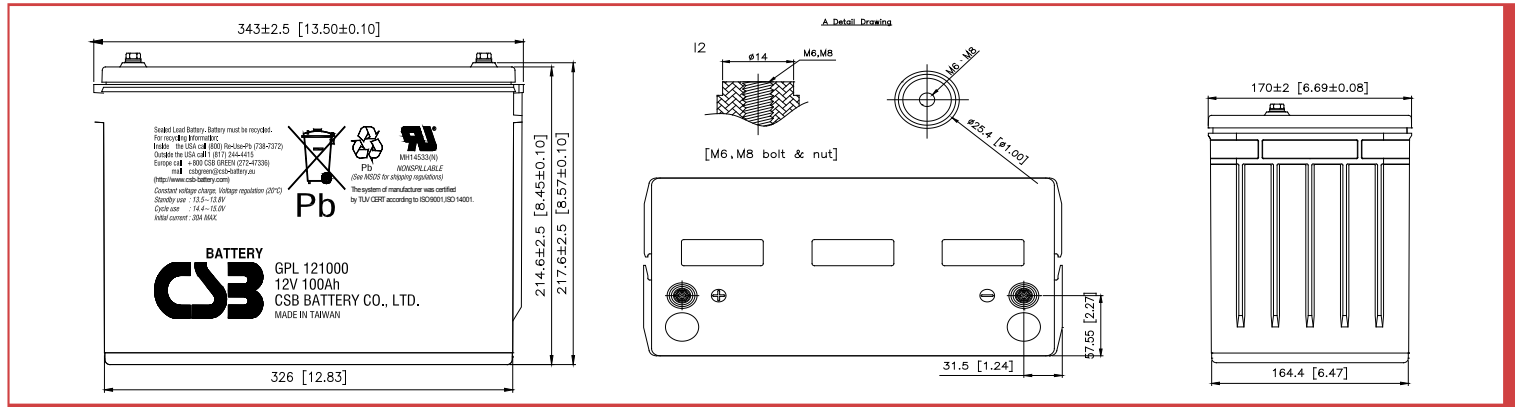

Constant Current Discharge Characteristics Unit:A (25°C ,77°F)

F.V/Time	5MIN	10MIN	15MIN	30MIN	1HR	2HR	3HR	4HR	5HR	8HR	10HR	20HR
1.60V	423	277	212	127	73.0	41.1	29.1	22.8	18.9	12.2	10.0	5.28
1.67V	375	266	207	125	72.4	40.7	29.0	22.7	18.8	12.1	9.93	5.23
1.70V	355	258	203	124	71.8	40.6	28.7	22.6	18.6	12.0	9.89	5.21
1.75V	317	240	194	120	71.1	40.2	28.6	22.4	18.5	11.9	9.82	5.19
1.80V	283	219	183	115	68.9	39.3	27.9	22.0	18.2	11.8	9.66	5.10
1.85V	245	196	164	106	65.2	37.6	26.8	21.2	17.4	11.4	9.45	4.92

Constant Power Discharge Characteristics Unit:W (25°C ,77°F)

F.V/Time	5MIN	10MIN	15MIN	30MIN	1HR	2HR	3HR	4HR	5HR	8HR	10HR	20HR
1.60V	4,159	2,950	2,331	1,436	849	482	342	269	223	153	125	63.5
1.67V	4,008	2,837	2,273	1,417	843	480	340	268	222	152	124	63.3
1.70V	3,863	2,772	2,252	1,404	840	478	339	266	221	151	123	63.2
1.75V	3,572	2,623	2,181	1,372	830	475	337	265	220	150	122	62.4
1.80V	3,184	2,442	2,049	1,316	809	465	331	261	217	148	121	61.4
1.85V	2,769	2,227	1,856	1,234	767	444	320	252	210	142	117	60.0

Trickle (or Float) Service Life

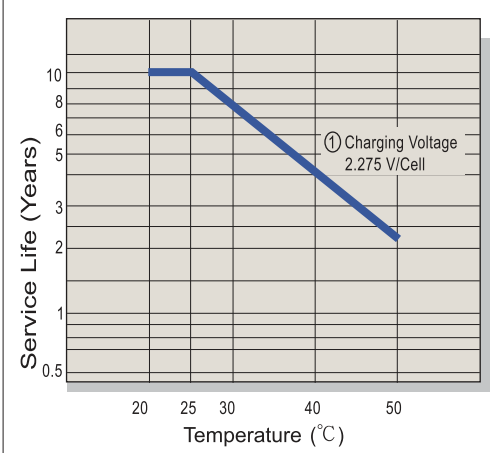

Capacity Retention Characteristic

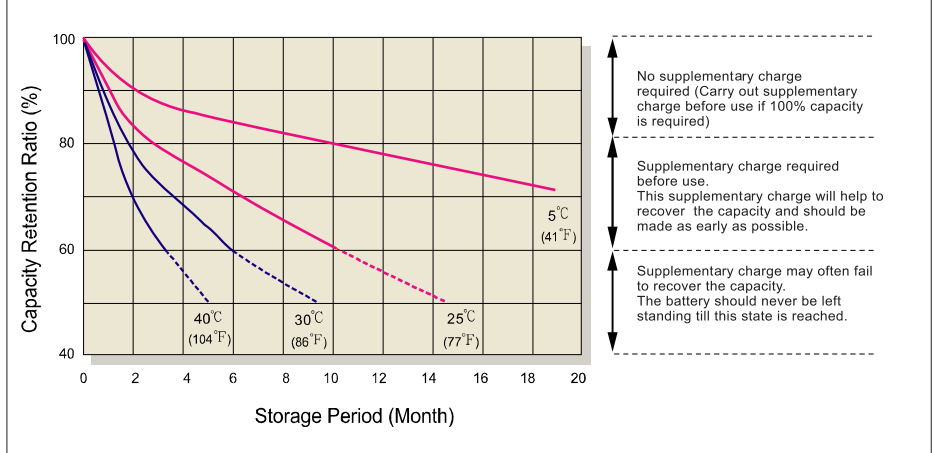

Battery Voltage and Charge Time for Standby Use

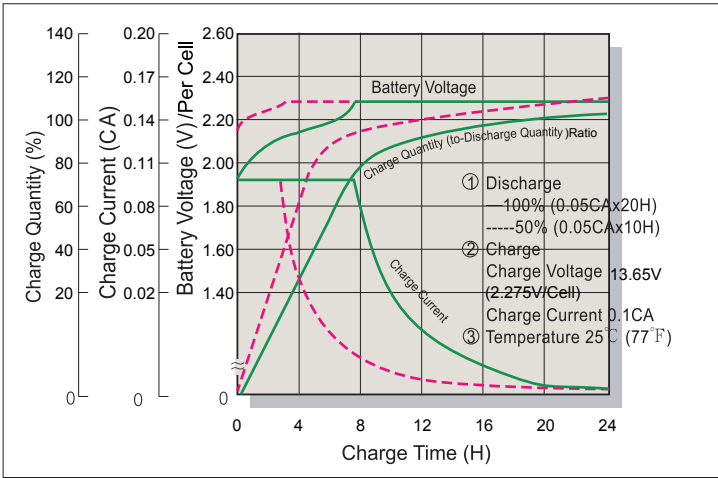

Cycle Service Life

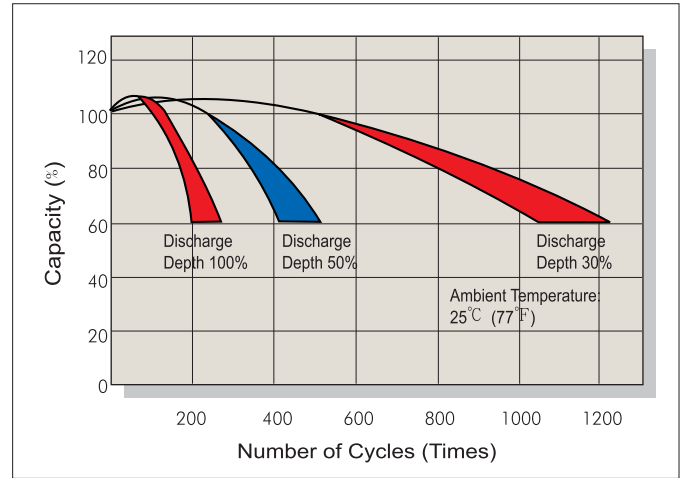

Battery Voltage and Charge Time for Cycle Use

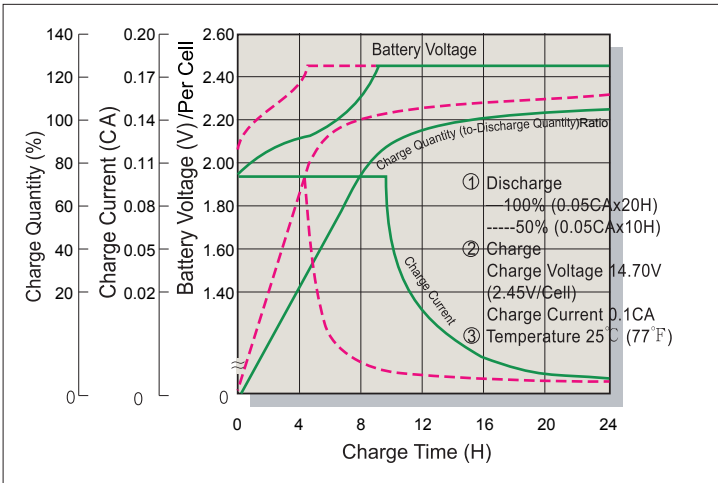

Terminal Voltage (V) and Discharge Time

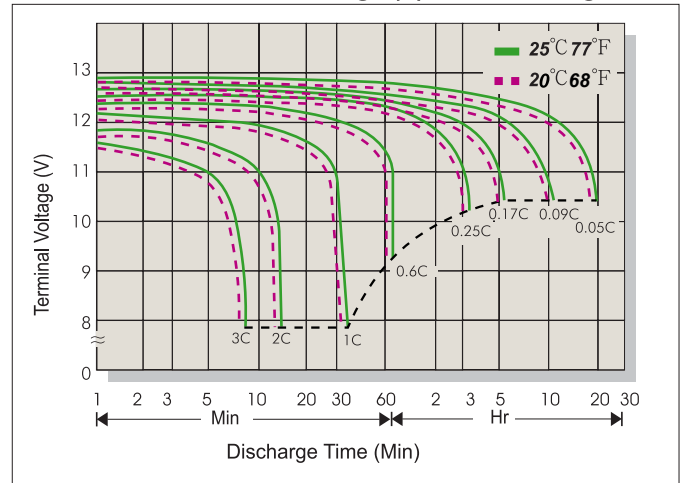

Charging Procedures

Application	Charge Voltage(V/Cell)			Max.Charge Current
	Temperature	Set Point	Allowable Range	
Cycle Use	25°C(77°F)	2.45	2.40~2.50	0.3C
Standby	25°C(77°F)	2.275	2.25~2.30	

Discharge Current VS. Discharge Voltage

Final Discharge Voltage V/Cell	1.75	1.70	1.60	1.30
Discharge Current(A)	0.2C>(A)	0.2C<(A)<0.5C	0.5C<(A)<1.0C	(A)>1.0C

Sales Office URL: WWW.CSB-BATTERY.COM

GLOBAL HQ
CSB BATTERY CO., LTD. (TAIWAN)
 Tel : +886-2-2555-5600
 Fax : +886-2-2555-3300
 mail : service@csb-battery.com.tw

BEIJING OFFICE. (CHINA)
CSB BATTERY TECHNOLOGIES (BEIJING) CO., LTD.
 Tel : +86-10-59621300/1301/1302/1303
 Fax : +86-10-59621304
 mail : chinasl@csb-battery.com

AMERICA HQ
CSB BATTERY TECHNOLOGIES INC. (U.S.A)
 Tel : +1-817-244-7777/1-(800)3-CSB-USA(272872)
 Fax : +1-817-244-4445
 mail : csb@csb-battery.com

SHANGHAI OFFICE. (CHINA)
CSB BATTERY LOGISTIC (SHANGHAI) CO., LTD.
 Tel : +86-21-5046-1622/5046-0833
 Fax : +86-21-5064-3314
 mail : chinasl@csb-battery.com

EUROPE HQ
CSB Battery Europe BV.
 Tel : +31(0)-180-418-140
 Fax : +31(0)-180-418-327
 mail : eurosales@csb-battery.eu

SHENZHEN OFFICE. (CHINA)
CSB BATTERY LOGISTIC (SHANGHAI) CO., LTD.
 Tel : +86-755-8831-6488/6396/6356
 Fax : +86-755-8831-6548
 mail : she@csb-battery.com.cn